



7 • Water Filters



Introduction	7-3
Filter Heads	7-6
Extended Service Interval Filters	7-8
Standard Service Interval Filters	7-10

Water (Coolant) Filtration Technology

The function of the coolant system in a diesel engine is to:

- Absorb heat from engine components
- Circulate coolant in the engine
- Dissipate heat through the radiator
- Control coolant temperature
- Cool exhaust gas used for NOx control (EGR)

Coolant systems utilize a combination of coolant, supplemental coolant additives and filtration. Diesel engines have commonly been equipped with at least a basic water filtration device, which filters the water/coolant solution in the coolant system. However, several engine manufacturers have recently begun to remove water filters from the engine, despite the fact that it is estimated that up to 40% of diesel engine repairs arise from problems beginning in the coolant system, and a large portion of these problems could be prevented by the use of water filtration.

In addition, significant changes in global diesel emissions standards have driven even greater changes in coolant system temperatures, operating conditions, chemistry, and flow rates, driving the need for even better filtration. General confusion exists regarding water based coolants, glycol based coolants, and differing additive chemistries (such as Organic Acid Technology (OAT), Hybrid, and Conventional). At the same time, extended service intervals versus more standard service intervals have complicated coolant system maintenance and confused maintenance professionals around the world.

The need has never been greater for water filters as part of a complete preventive maintenance regimen. A complete regimen consists of a quality fully formulated coolant, which meets all of the engine manufacturers requirements and the use of superior coolant filtration to remove debris and contaminants that build up in coolants over time.

Coolant System Debris

Debris in the coolant system is common, which is a result of the manufacturing process and generated under normal operation, as well. The manufacturing process of engine hardware leaves core sand in the coolant system which causes wear in the high flow areas.

Over time, other debris, such as silt and dirt from the environment or poor maintenance practices, such as refilling with dirty water or the use of dirty containers, enters the coolant system. This dirt and silt causes significant abrasive wear throughout the coolant system.

Poor quality coolants, spent/degraded additives or over-treatment of supplemental additives will result in additive precipitation. These insoluble additives add to the level of debris in the coolant, aggravate wear, and heat transfer problems.

Lastly, if maintenance practices involve the use of hard water, scale can form on hot surfaces such as liners, cylinder heads, and water pump seal faces, causing unnecessary downtime. Filtering these harmful contaminants from the engine coolant reduces engine wear, radiator failure, water pump failure, overheating, thermostat failure, and other coolant system component problems.

Fully Formulated Coolants

Engine manufacturers always recommend using a fully formulated coolant. Fully formulated coolants contain the appropriate amounts of glycol, de-ionized water and heavy duty additive package mixed together as a complete coolant package. Fully formulated coolants still need to have the SCA replaced at specific service intervals, depending on the type of fully formulated coolant/additive package used. There are *standard service interval coolants* and *extended service interval coolants*. Water filters containing SCA can provide a convenient and reliable method for delivering supplemental additives and coolant extenders which replenish the additive chemistries used during the respective service interval.

Specifying the Right Water Filter for the Job

Several possible strategies can be pursued in applying water filters to your coolant system. Each is dependent on:

- The type of additive to be used
- The service interval intended
- The perceived needs of the equipment operator
- The size of the coolant system
- The engine manufacturer's requirements



Introduction

Common reasons for choosing a water filter are:

1. Adding Water Filter *Capability* to an Existing Coolant System.

The addition of a Fleetguard® water filter head and filter can provide significant benefits to the engine, including:

- Extended water pump life
- Maximized cavitation corrosion protection
- Extended coolant life
- Improved heat transfer
- Improved thermostat durability
- Lower cooling system maintenance costs

The following coolant related problems are possible signs of debris/contaminant in the coolant coupled with poor to no filtration:

- Worn rings and scuffed pistons due to poor heat transfer
- Premature water pump failures
- Premature thermostat failures
- Premature radiator failures

Field tests returns have noted that 40% of used water filters evaluated contained moderate amounts of contaminant and greater than 10% contained heavy amounts. In addition, a survey of over 11,600 engines operating with and without water filters noted a 3 to 1 reduction in water pump seal leakage between fleets using filters and those which do not (SAE Technical Paper Series 881270).

The addition of a Fleetguard water filter head and filter is highly recommended. Please refer to the following pages for the appropriate head and water filter combination.

2. UTILIZATION WITH A STANDARD MAINTENANCE INTERVAL COOLANT SYSTEM

Once an engine has a water filter, either as part of the initial engine or added as described above, it is important to determine the service interval for the equipment. A standard service interval is less than 500 hours, 25,000 mi or 40,000 km.

Standard service interval water filters containing SCA can provide the appropriate amount of supplemental coolant additive required to replenish those additives utilized during the service interval. The following chart lists the proper amount of SCA for every 250 hours, 12,500 mi or 20,000 km, according to the coolant system capacity.

System Size gal (L)	Typical Number of SCA Units Needed to be Replenished After 250 Hours of Service
1 - 5 (4 - 19)	2
6 - 10 (20 - 38)	2
11 - 15 (42 - 57)	4
16 - 20 (60 - 76)	6
21 - 38 (79 - 144)	10
31 - 50 (117 - 189)	15
51 - 75 (193 - 284)	20
76 - 100 (288 - 378)	25
101 - 150 (382 - 568)	40
151 - 200 (572 - 757)	50
201 - 250 (761 - 946)	65
251 - 300 (950 - 1135)	75
301 - 350 (1139 - 1325)	90
351 - 416 (1329 - 1574)	100

3. UTILIZATION WITH AN EXTENDED MAINTENANCE INTERVAL COOLANT SYSTEM

Extended Service Interval (ESI) filters are recommended for use up to one year, 150,000 mi, 250,000 km or 4,000 hours, whichever comes first, on engines with coolant systems up to 20 gal (76 L).

For coolant systems above 20 gal (76 L), or if a liquid extender or SCA is used instead of a filter to replenish the SCA, blank water filters are recommended. For Organic Acid Technology (OAT) coolants, blank water filters should be combined with a liquid extender.

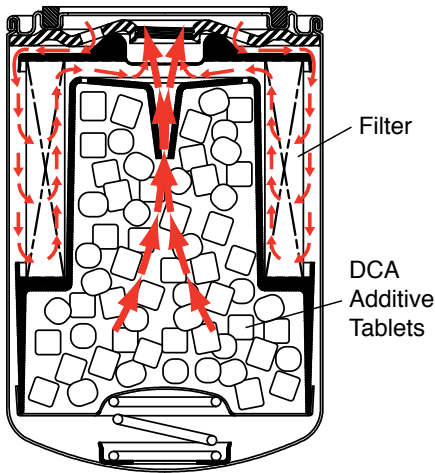

Fleetguard® ESI water filters are specifically designed to release the proper amount of coolant additive in order to provide the appropriate coolant system protection over time through a patented coated tablet technology. These tablets are held in a special chamber which prevents the tablets from dissolving too quickly and introducing excess additive into the coolant system.

Additionally, Fleetguard ESI filters utilize proprietary StrataPore™ media made of polypropylene material which naturally captures oil and meets the durability requirements of extended service intervals not met by cellulose media.

Finally, the shells have been designed with heavier steel than standard service interval water filters. Springs with plastic protector cups ensure proper performance over the life of the service interval. These filters have been specially designed to meet all of the requirements of a demanding extended service interval.

Details of the Application for Adding on a Water Filter

After initially deciding the type of coolant, water filter and filter head required, it is important to examine application specifications to choose the precise parts for your system's needs.

1. Physical package size and location determine specifically where the water filter can be mounted and how large it can be. This space must also include enough clearance for service and filter removal.
2. Environmental parameters must be considered for proper installation. These parameters can include:
 - a. Maximum and minimum temperatures
 - b. Vibration
 - c. Hose diameter and length
 - d. Housing pressure
 - e. Restriction
 - f. Types of fittings and shut-off valves
3. Coolant system capacity dictates the amount of coolant additive required for proper protection. See the chart on the previous page for SCA requirements.
4. How far you want to go between service intervals determines whether standard or extended service intervals are required.
5. The three basic additive chemistries – DCA2, DCA4 and OAT – dictate which filter should be used. Contact Cummins Filtration® Technical Assistance for additional information on which filters work best with each type of chemistry.

Summary

Today's modern diesel engines and coolant systems face many challenges. Ongoing governmental emissions regulations continue to drive the performance of engines and coolant systems. Due to these changes, coolant systems face many demanding conditions. Each water filter should be carefully tailored to provide the proper protection and chemical additives. Close attention must be devoted to system maintenance.

Water filtration is more important than ever. Coolant systems require more protection and proper additive protection than in years past. Choose Fleetguard water filters and coolant system products to keep your engine running better for longer.

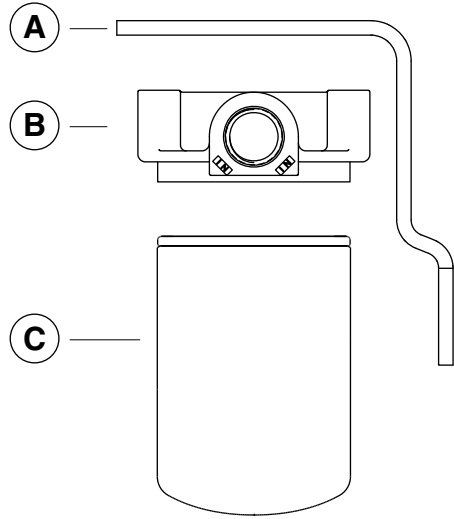

Parts List

Part	Description	Part Number
A	Water Filter Mounting Bracket	256535 S
B	Filter Head	See Ordering Information
C	Replacement Filter	See Ordering Information

Ordering Information

Filter Head Part Number*	Description	Style	Port Size	Thread Size
204163 S	Water Filter Spin-On Head	Aluminum	3/8" NPT	11/16-16 UN-2B
215617 S	Dual Water Filter Spin-On Heads	Aluminum	1/2" NPT	11/16-16 UN-2B
256535 S	Filter Head Mounting Bracket	-	-	-
257715 S	Water Filter Head (204163 S) and Mounting Bracket Assembly	Aluminum Head	3/8" NPT	11/16-16 UN-2B
3904378 S	Severe Duty Water Filter Head	Steel	3/8" NPT	11/16-16 UN-2B

* Severe Duty Filter Head is recommended for most applications.

Replacement Filters

Part Number	Description
WF2071	Spin-On Filter with DCA4+ Additive
WF2121	Spin-On Filter with Slow Release DCA4+ Additive
WF2122	Spin-On Filter with No Additive
WF2123	Spin-On Filter with No Additive
WF2131	Spin-On Filter with Slow Release DCA2+ Additive

Note: The filters shown in this table are representative of the types of filters available for these Water Filter Heads. For a complete listing of all available filters, see the tables on the following pages.

Mounting/Dimensions

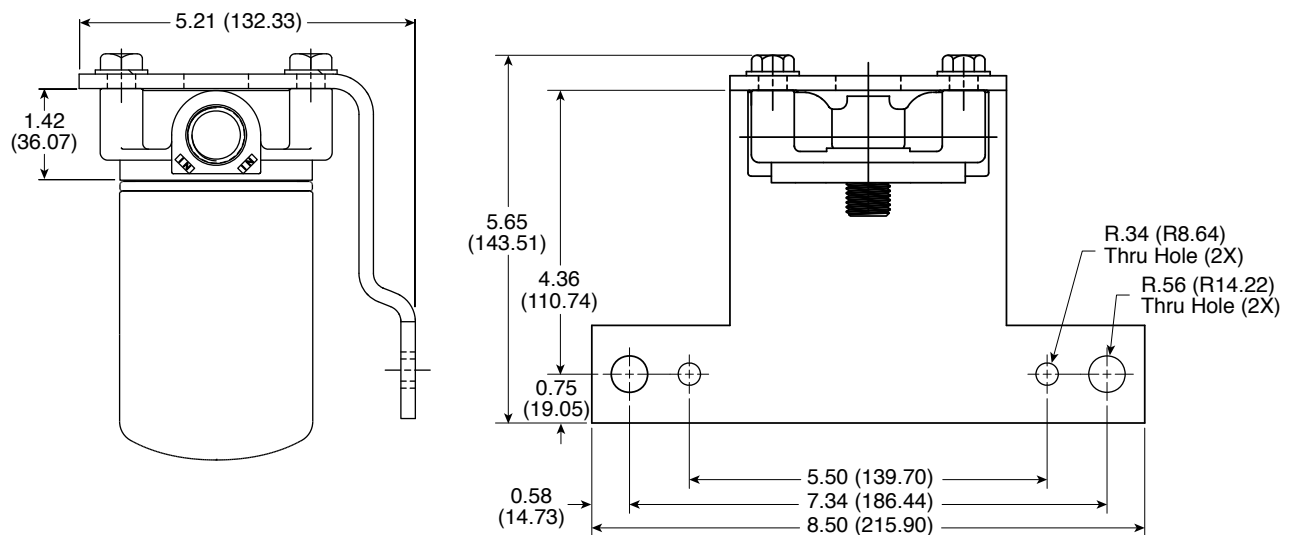

All dimensions are in inches (millimeters)

Extended Service Interval Filters are recommended for use up to one year, 150,000 miles, 250,000 kilometers, or 4000 hours (whichever comes first).

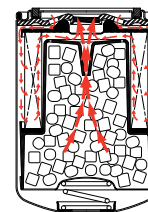

Spin-On Filters with Slow Release DCA4+ Additive

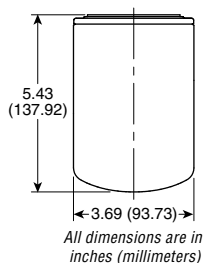

Part Number	Media Type	Micron Rating	Coolant Additive	Dome Outside Diameter in (mm)	Overall Height in (mm)	Thread Size
WF2121	StrataPore™	40	15 Units	3.69 (93.73)	5.43 (137.92)	11/16-16 UN- 2B
WF2124	StrataPore	40	15 Units	3.69 (93.73)	5.43 (137.92)	3/4-20 UNEF- 2B
WF2128	StrataPore	40	15 Units	3.69 (93.73)	5.43 (137.92)	M16 X 1.5-6H INT

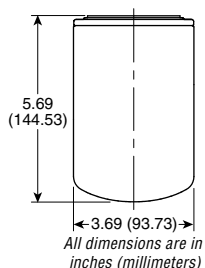

Part Number	Media Type	Micron Rating	Coolant Additive	Dome Outside Diameter in (mm)	Overall Height in (mm)	Thread Size
WF2126	StrataPore™	40	15 Units	3.69 (93.73)	5.69 (144.53)	M36 X 2-6G INT

Spin-On Filters with Slow Release DCA2+ Additive

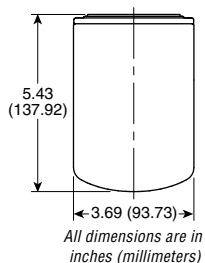

Part Number	Media Type	Micron Rating	Coolant Additive	Dome Outside Diameter in (mm)	Overall Height in (mm)	Thread Size
WF2131	StrataPore™	40	15 Units	3.69 (93.73)	5.43 (137.92)	11/16-16 UN-2B
WF2133	StrataPore	40	15 Units	3.69 (93.73)	5.43 (137.92)	3/4-20 UNEF-2B
WF2138	StrataPore	40	15 Units	3.69 (93.73)	5.43 (137.92)	M16 X 1.5-6H INT

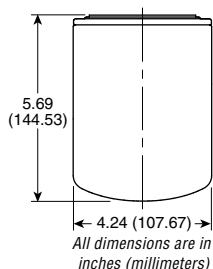

Part Number	Media Type	Micron Rating	Coolant Additive	Dome Outside Diameter in (mm)	Overall Height in (mm)	Thread Size
WF2136	StrataPore™	40	15 Units	4.24 (107.67)	5.69 (144.53)	1-16 UN-2B

Note: All filters, except where noted, have a restrictive orifice that ensures a maximum flow of 2 gal/min (7.6 L/min). Media micron rating is 98.7% efficient at rated flow as determined by a modified ISO 4548-12. Specifications subject to change without notice.

Extended Service Interval Filters are recommended for use up to one year, 150,000 miles, 250,000 kilometers, or 4000 hours (whichever comes first).

Spin-On Filters with No Additive

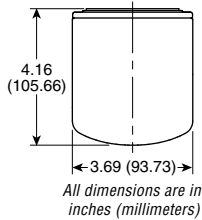

Part Number	Media Type	Micron Rating	Coolant Additive	Dome Outside Diameter in (mm)	Overall Height in (mm)	Thread Size
WF2122	StrataPore™	40	None	3.69 (93.73)	4.16 (105.66)	11/16-16 UN- 2B
WF2129	StrataPore	40	None	3.69 (93.73)	4.16 (105.66)	M16 X 1.5-6H INT
WF2134	StrataPore	40	None	3.69 (93.73)	4.16 (105.66)	3/4-20 UNEF- 2B

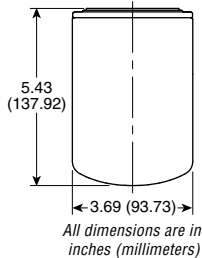

Part Number	Media Type	Micron Rating	Coolant Additive	Dome Outside Diameter in (mm)	Overall Height in (mm)	Thread Size
WF2123*	StrataPore™	40	None	3.69 (93.73)	5.43 (137.92)	11/16-16 UN- 2B
WF2130	StrataPore	40	None	3.69 (93.73)	5.43 (137.92)	M16 X 1.5-6H INT
WF2139	StrataPore	40	None	3.69 (93.73)	5.43 (137.92)	11/16-16 UN- 2B

* Full-flow filter (no restrictive orifice) which allows greater than 2 gal/min (7.6 L/min) maximum flow.

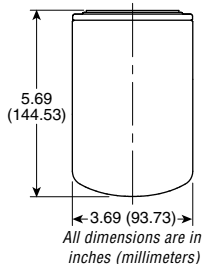

Part Number	Media Type	Micron Rating	Coolant Additive	Dome Outside Diameter in (mm)	Overall Height in (mm)	Thread Size
WF2127	StrataPore™	40	None	3.69 (93.73)	5.69 (144.53)	M36 X 2-6G INT

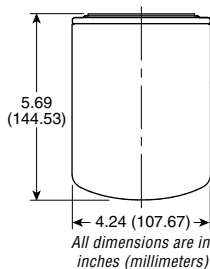

Part Number	Media Type	Micron Rating	Coolant Additive	Dome Outside Diameter in (mm)	Overall Height in (mm)	Thread Size
WF2137	StrataPore™	40	None	4.24 (107.67)	5.69 (144.53)	1-16 UN-2B

Note: All filters, except where noted, have a restrictive orifice that ensures a maximum flow of 2 gal/min (7.6 L/min). Media micron rating is 98.7% efficient at rated flow as determined by a modified ISO 4548-12. Specifications subject to change without notice.

Standard Service Interval Filters are recommended for use up to 500 hours, 25,000 miles, 40,000 kilometers, or each oil change interval (whichever comes first).

Spin-On Filters with Immediate Release DCA4+ Additive

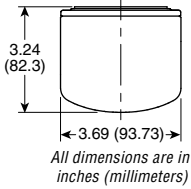

Part Number	Media Type	Micron Rating	Coolant Additive	Dome Outside Diameter in (mm)	Overall Height in (mm)	Thread Size
WF2093	Cellulose	60	5 Units	3.69 (93.73)	3.24 (82.3)	11/16-16 UN- 2B

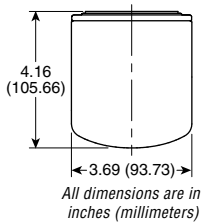

Part Number	Media Type	Micron Rating	Coolant Additive	Dome Outside Diameter in (mm)	Overall Height in (mm)	Thread Size
WF2070	Cellulose	60	2 Units	3.69 (93.73)	4.16 (105.66)	11/16-16 UN- 2B
WF2071	Cellulose	60	4 Units	3.69 (93.73)	4.16 (105.66)	11/16-16 UN- 2B
WF2072	Cellulose	60	6 Units	3.69 (93.73)	4.16 (105.66)	11/16-16 UN- 2B
WF2073	Cellulose	60	8 Units	3.69 (93.73)	4.16 (105.66)	11/16-16 UN- 2B
WF2087	Cellulose	60	9 Units	3.69 (93.73)	4.16 (105.66)	11/16-16 UN- 2B
WF2151	Cellulose	60	4 Units	3.69 (93.73)	4.16 (105.66)	11/16-16 UN- 2B

Note: All filters, except where noted, have a restrictive orifice that ensures a maximum flow of 2 gal/min (7.6 L/min). Media micron rating is 98.7% efficient at rated flow as determined by a modified ISO 4548-12. Specifications subject to change without notice.

Standard Service Interval Filters are recommended for use up to 500 hours, 25,000 miles, 40,000 kilometers, or each oil change interval (whichever comes first).

Spin-On Filters with Immediate Release DCA4+ Additive

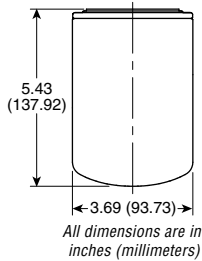

Part Number	Media Type	Micron Rating	Coolant Additive	Dome Outside Diameter in (mm)	Overall Height in (mm)	Thread Size
WF2015	Cellulose	60	8 Units	3.69 (93.73)	5.43 (137.92)	3/4-20 UNEF- 2B
WF2074	Cellulose	60	12 Units	3.69 (93.73)	5.43 (137.92)	5.43 (137.92)
WF2075	Cellulose	60	15 Units	3.69 (93.73)	5.43 (137.92)	11/16-16 UN- 2B
WF2076	Cellulose	60	23 Units	3.69 (93.73)	5.43 (137.92)	11/16-16 UN- 2B
WF2083	Cellulose	60	4 Units	3.69 (93.73)	5.43 (137.92)	3/4-20 UNF-2B
WF2104	Cellulose	60	15 Units	3.69 (93.73)	5.43 (137.92)	11/16-16 UN- 2B
WF2106	Cellulose	60	4 Units	3.69 (93.73)	5.43 (137.92)	11/16-16 UN- 2B
WF2108	Cellulose	60	8 Units	3.69 (93.73)	5.43 (137.92)	M16 X 1.5-6H INT

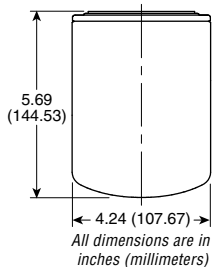

Part Number	Media Type	Micron Rating	Coolant Additive	Dome Outside Diameter in (mm)	Overall Height in (mm)	Thread Size
WF2022	Cellulose	60	8 Units	4.24 (107.67)	5.69 (144.53)	1-16 UN-2B
WF2082	Cellulose	60	6 Units	4.24 (107.67)	5.69 (144.53)	1-16 UN-2B

Note: All filters, except where noted, have a restrictive orifice that ensures a maximum flow of 2 gal/min (7.6 L/min). Media micron rating is 98.7% efficient at rated flow as determined by a modified ISO 4548-12. Specifications subject to change without notice.

Standard Service Interval Filters are recommended for use up to 500 hours, 25,000 miles, 40,000 kilometers, or each oil change interval (whichever comes first).

Spin-On Filters with Immediate Release DCA2 Additive

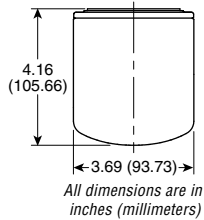

Part Number	Media Type	Micron Rating	Coolant Additive	Dome Outside Diameter in (mm)	Overall Height in (mm)	Thread Size
WF2051	Cellulose	60	4 Units	3.69 (93.73)	4.16 (105.66)	11/16-16 UN- 2B
WF2088	Cellulose	60	8 Units	3.69 (93.73)	4.16 (105.66)	11/16-16 UN- 2B

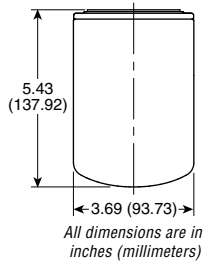

Part Number	Media Type	Micron Rating	Coolant Additive	Dome Outside Diameter in (mm)	Overall Height in (mm)	Thread Size
WF2054	Cellulose	60	15 Units	3.69 (93.73)	5.43 (137.92)	11/16-16 UN- 2B
WF2144	Cellulose	60	12 Units	3.69 (93.73)	5.43 (137.92)	11/16-16 UN-2B

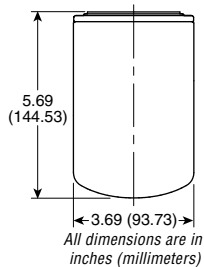

Part Number	Media Type	Micron Rating	Coolant Additive	Dome Outside Diameter in (mm)	Overall Height in (mm)	Thread Size
WF2069	Cellulose	60	8 Units	3.69 (93.73)	5.69 (144.53)	11/16-16 UN- 2B
WF2096	Cellulose	60	8 Units	3.69 (93.73)	5.69 (144.53)	M16 X 1.5-6H INT

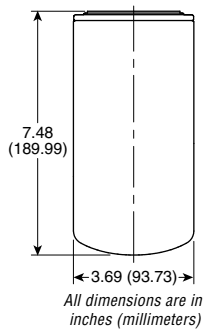

Part Number	Media Type	Micron Rating	Coolant Additive	Dome Outside Diameter in (mm)	Overall Height in (mm)	Thread Size
WF2145	Cellulose	60	18 Units	3.69 (93.73)	7.48 (189.99)	11/16-16 UN-2B

Note: All filters, except where noted, have a restrictive orifice that ensures a maximum flow of 2 gal/min (7.6 L/min). Media micron rating is 98.7% efficient at rated flow as determined by a modified ISO 4548-12. Specifications subject to change without notice.

Standard Service Interval Filters are recommended for use up to 500 hours, 25,000 miles, 40,000 kilometers, or each oil change interval (whichever comes first).

Spin-On Filters with Immediate Release DCA2 Additive

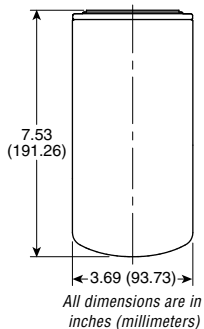

Part Number	Media Type	Micron Rating	Coolant Additive	Dome Outside Diameter in (mm)	Overall Height in (mm)	Thread Size
WF2053	Cellulose	60	8 Units	3.69 (93.73)	7.53 (191.26)	11/16-16 UN- 2B
WF2055	Cellulose	60	23 Units	3.69 (93.73)	7.53 (191.26)	11/16-16 UN- 2B

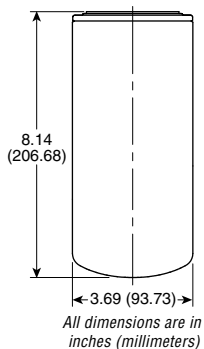

Part Number	Media Type	Micron Rating	Coolant Additive	Dome Outside Diameter in (mm)	Overall Height in (mm)	Thread Size
WF2091	Cellulose	60	14 Units	4.24 (107.67)	8.14 (206.68)	11/16-16 UN-2B

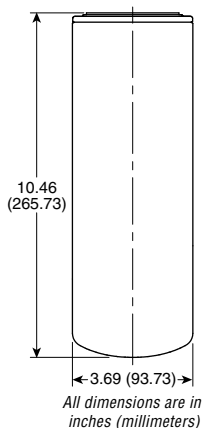

Part Number	Media Type	Micron Rating	Coolant Additive	Dome Outside Diameter in (mm)	Overall Height in (mm)	Thread Size
WF2056	Cellulose	60	34 Units	4.24 (107.67)	10.46 (265.73)	11/16-16 UN- 2B

Note: All filters, except where noted, have a restrictive orifice that ensures a maximum flow of 2 gal/min (7.6 L/min). Media micron rating is 98.7% efficient at rated flow as determined by a modified ISO 4548-12. Specifications subject to change without notice.

Standard Service Interval Filters are recommended for use up to 25,000 miles, 40,000 kilometers, or each oil change interval (whichever comes first).

Spin-On Filters with No Additive

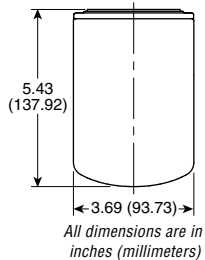

Part Number	Media Type	Micron Rating	Coolant Additive	Dome Outside Diameter in (mm)	Overall Height in (mm)	Thread Size
WF2077	Cellulose	60	None	3.69 (93.73)	5.43 (137.92)	11/16-16 UN- 2B
WF2078	Cellulose	60	None	3.69 (93.73)	5.43 (137.92)	3/4-20 UNF-2B
WF2101	Cellulose	60	None	3.69 (93.73)	5.43 (137.92)	11/16-16 UN- 2B
WF2109	None – No Media	60	None	3.69 (93.73)	5.43 (137.92)	M16 X 1.5-6H INT

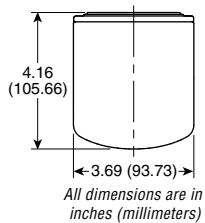

Part Number	Media Type	Micron Rating	Coolant Additive	Dome Outside Diameter in (mm)	Overall Height in (mm)	Thread Size
WF2084	Cellulose	60	None	3.69 (93.73)	4.16 (105.66)	11/16-16 UN- 2B
WF2107	Cellulose	60	None	3.69 (93.73)	4.16 (105.66)	11/16-16 UN- 2B

Note: All filters, except where noted, have a restrictive orifice that ensures a maximum flow of 2 gal/min (7.6 L/min). Media micron rating is 98.7% efficient at rated flow as determined by a modified ISO 4548-12. Specifications subject to change without notice.